

SERVICE BULLETIN

SB No.

68

Issue No.

4

TITLE

CANOPY LATCH CORRECT OPERATION INSPECTION

CLASSIFICATION

This Service Bulletin has been classified as Highly Recommended

COMPLIANCE

Within 50 Flying Hours if Issue 3 not complied with otherwise as per para xi)

This Issue 4 is raised to add the following information.

Canopy seal information added and 2.5mm gap at Para (ii) was 1mm. Fig. 1 altered accordingly.

APPLICABILITY:

T67M-MkII, T67M260, T67M260-T3A and any T67C, T67M and T67M200 Aircraft Post Mod M129/M129B (Split Canopy),

INTRODUCTION:

An incident has occurred where the canopy latch was apparently closed correctly but when engine revs were increased beyond 1500 RPM the canopy opened.

Additionally, upon aircraft delivery and on subsequent canopy seal replacement, further incidents have been reported of the canopy lifting off its locating lug/s at high speed. Whilst the canopy does not unlatch, it does cause the pilot some concern. When the speed reduces, the canopy does not settle onto its locating lug/s at the sides, but down to one side causing unnecessary draught and noise.

These incidents have typically occurred within 20 flying hours of delivery of a new aircraft or the fitting of a new canopy seal. Following investigation, the cause was found to be due to the rubber seal taking up a permanent set.

Fig. 1 page 2 shows 3 positions of the canopy mechanism:

Position 1 - Open/Unlatched

Position 2 - Latched but mechanism not over centre

Position 3 - Correctly closed, mechanism fully over centre.

ACTION:

- (i) Remove canopy mechanism and latch covers
- (ii) Close canopy fully. Ensure internal handle is in its correct position and external handle is in its correct position, ie touching bush or no more than 2.5mm gap. Fig. 1.

ISSUED BY:



Date 27-9-97

for and on behalf of

SLINGSBY AVIATION LIMITED
Kirkbymoorside, York YO6 6EZ England

Tel. 01751 432474
Fax 01751 431173

Page 1 of 5

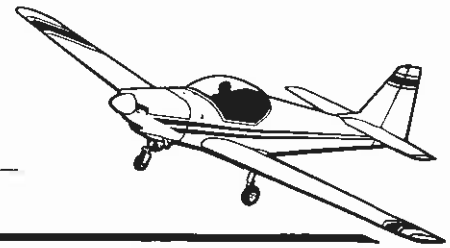
**SERVICE BULLETIN**

SB No.

68

Issue No. 4

TITLE

CANOPY LATCH CORRECT OPERATION INSPECTION

CONTINUED

- (iii) Check that stop pin is just touching latch hook or no more than 1mm from it. If not adjust in accordance with Maintenance Manual, Section 3, paragraphs 3.2.
- (iv) If (ii) and (iii) cannot be met after adjustment, then it is acceptable to slot latch block Ref. Fig. 3. Suitably re-protect cut surfaces and re-identify block as Part Number T67G-17-531 Post Mod M713B. Annotate Logbook accordingly.
- (v) Check closure. By positioning palm of hand at point indicated, ref. Fig. 1, push up latch handle, which should close with reasonable resistance but without using excessive force.
- (vi) Replace mechanism and latch covers, in accordance with Maintenance Manual, Section 3, paragraphs 3.2.
- (vii) Maintenance Manuals to be amended to reflect points contained in (ii), (iii), (iv) and (v).
- (viii) When handle is fully closed, ie meets requirements of Fig. 1, mark a white line across both labels ref. Fig. 2 on line with handle lower surface (ie coincident with Point 'A' ref Fig. 1 & 2. The line may be obtained by running a hacksaw across both labels; a) deep enough to reveal white of label material or b) if base material is red, deep enough to hold white fill in wax, ie 0.25mm to 0.5mm.

When label is marked, it is to be identified in IPC Ref. Chapter 15 as Part No. T67M-17-351 Post Mod M666, Part No. T67M-17-319 to be annotated Pre Mod M666. Annotate Logbook Mod M666 incorporated.
- (ix) Providing the mechanism is correctly adjusted it should be obvious to the pilot that the latch mechanism has gone overcentre.
- (x) On completion of this SB, annotate Logbook SB68 complied with.
- (xi) Should a new canopy/seal be fitted, the latch mechanism inspection, as outlined in this Service Bulletin should be repeated up to 25 flying hours after installation.

The Maintenance Manual will be amended at next amendment to reflect para (xi).

If in doubt, contact SAL Product Support Department.

Approved:

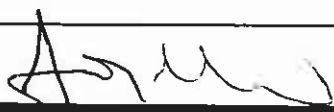

Date: 27-9-97

Page

2

of

5

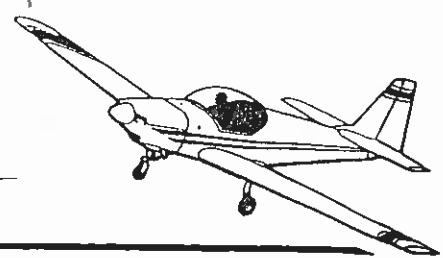

SERVICE BULLETIN

SB No.

68

Issue No. 4

TITLE

CANOPY LATCH CORRECT OPERATION INSPECTION

CONTINUED

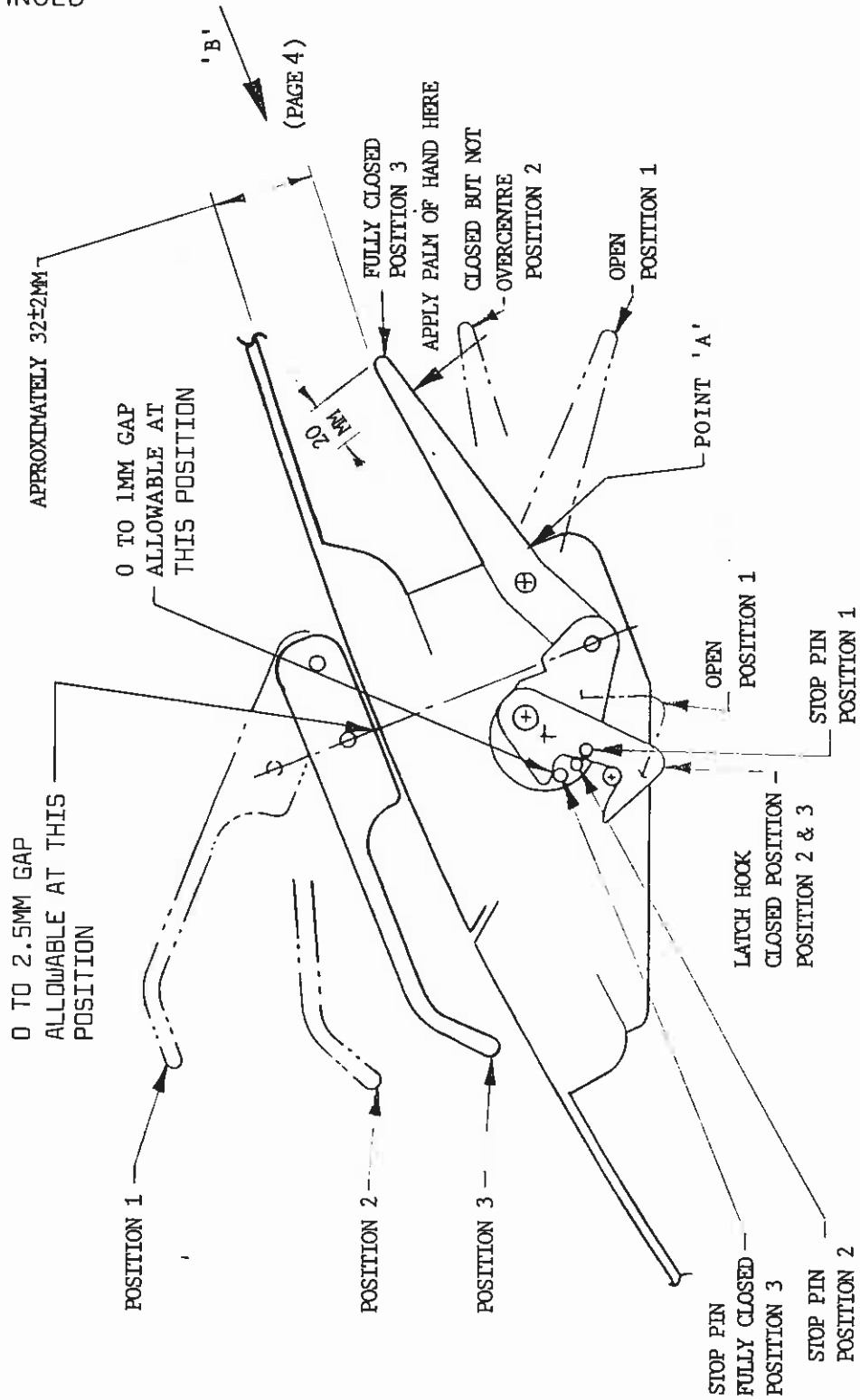
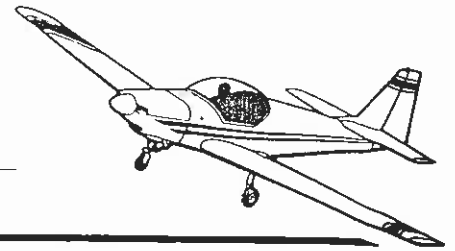

Fig 1

Approved: *[Signature]*

Date: 27-9-97

Page 3 of 5



SERVICE BULLETIN

SB No. 68

Issue No. 4

TITLE

CANOPY LATCH CORRECT OPERATION INSPECTION

CONTINUED

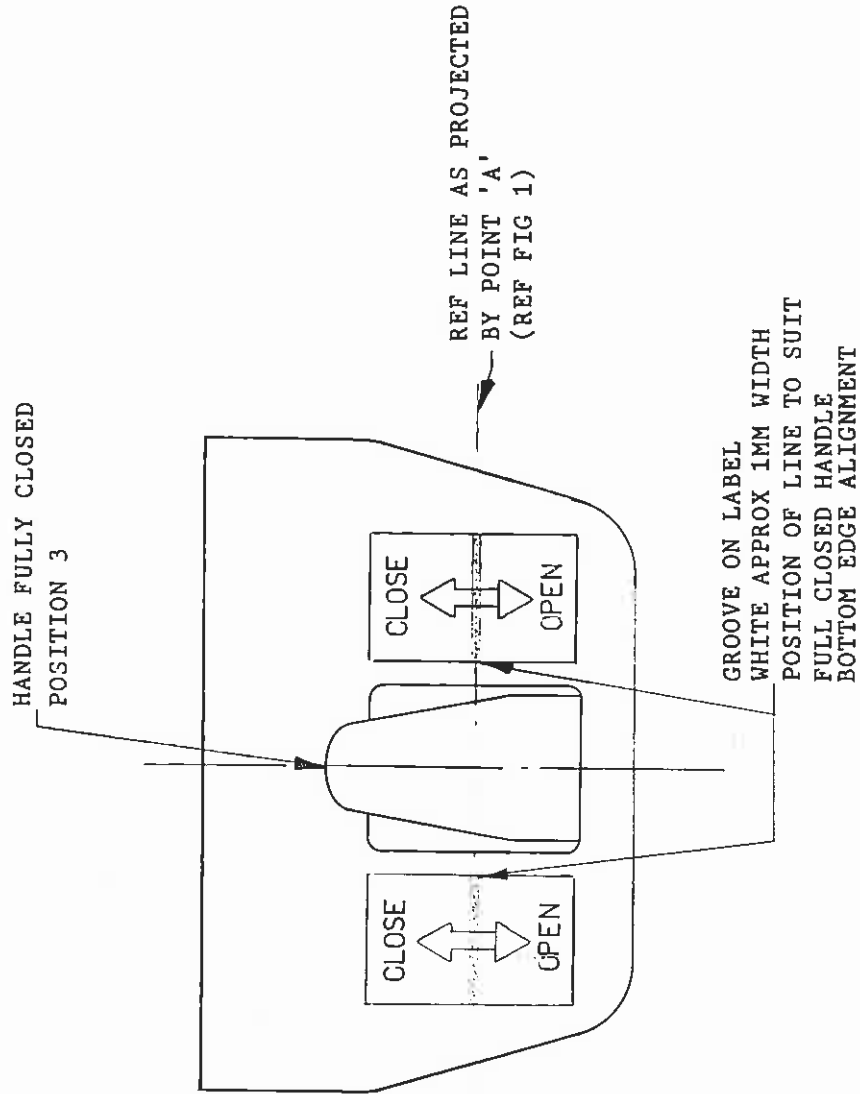

FIG 2
VIEW ON ARROW 'B' (REF FIG 1)

Approved:

Date:

27-9-97

Page

4

of

5

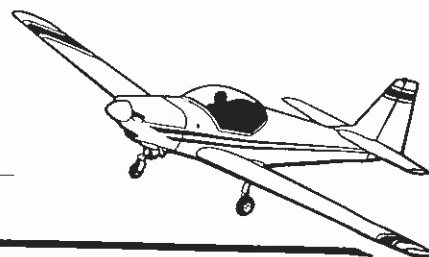

SERVICE BULLETIN

SB No. 68

Issue No. 4

TITLE

CANOPY LATCH CORRECT OPERATION INSPECTION

CONTINUED

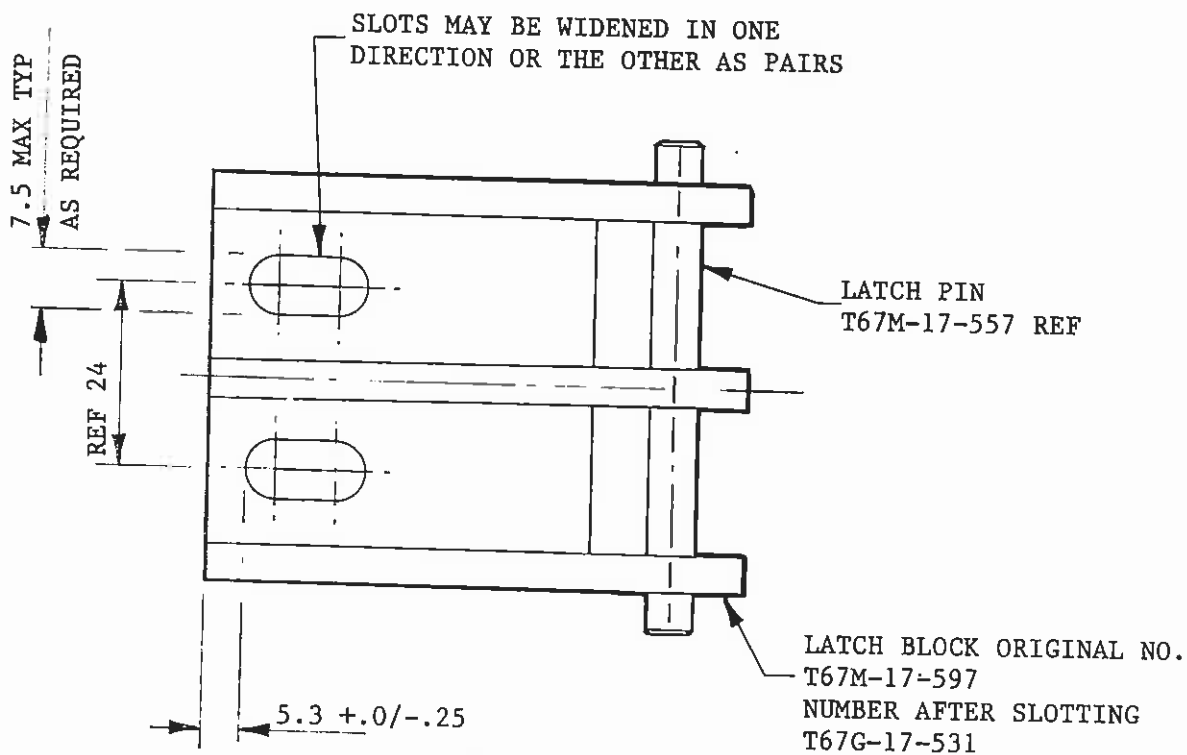

FIG 3

Approved:

Date: 27-9-97

Page 5 of 5